



More Upper Bounds on Taxicab and Cabtaxi Numbers

Po-Chi Su

Hsing-Hua Senior High School

Miaoli 35144

Taiwan

poky@webmail.mlc.edu.tw

Abstract

For positive integers a, b and integers x, y such that $S = a^3 + b^3 = x^3 + y^3$, we prove that $x + y \equiv a + b \pmod{6}$; moreover, we give a parametric function $r_i \rightarrow (x(r_i), y(r_i))$ with $(x(r_i))^3 + (y(r_i))^3 = a^3 + b^3$ for chosen parameters r_i , and we conjecture that most such S are multiples of 18 if S is large enough. Accordingly, *floating sieving* is introduced and upper bounds on the Cabtaxi numbers $\text{Ca}(n)$ with $43 \leq n \leq 57$, and the Taxicab numbers $\text{Ta}(n)$ with $n = 23, 24$ are given. Among them, $\text{Ta}(n)$ with $n = 23, 24$, and $\text{Ca}(n)$ with $n = 43, 44$, are included in the *On-Line Encyclopedia of Integer Sequences*.

1 Introduction

The n -th *Taxicab number* $\text{Ta}(n)$ (respectively, the n -th *Cabtaxi number* $\text{Ca}(n)$) is the smallest that can be expressed as a sum of two cubes of positive integers (respectively, integers) in n ways, which are called n *decompositions* [1, 2]. For any positive n , Fermat proved the existence of $\text{Ta}(n)$, as shown in the book by Hardy and Wright [4, Theorem 412]. Clearly, $\text{Ca}(n) \leq \text{Ta}(n)$ by definition. Specifically, Dardis found $\text{Ta}(5)$ in 1994, but $\text{Ta}(6)$ was not determined until 14 year later. Indeed, Wilson [5] found an upper bound on $\text{Ta}(6)$ in 1997,

$$\begin{aligned} \text{Ta}(6) &\leq 8, 230, 545, 258, 248, 091, 551, 205, 888 \\ &= 2^9 \cdot 3^3 \cdot 7 \cdot 13 \cdot 19^3 \cdot 31 \cdot 67^3 \cdot 79 \cdot 109^3. \end{aligned}$$

Rathbun improved this upper bound in 2002 to

$$\begin{aligned} \text{Ta}(6) &\leq 24,153,319,581,254,312,065,344 \\ &= 2^6 \cdot 3^3 \cdot 7^4 \cdot 13 \cdot 19 \cdot 43 \cdot 73 \cdot 79^3 \cdot 97 \cdot 157. \end{aligned}$$

Calude et al. [3] showed that this upper bound is $\text{Ta}(6)$ with a probability of greater than 0.99. Finally, in 2008, Hollerbach showed that it was exactly $\text{Ta}(6)$ [1, 2].

Clearly, the determinations of $\text{Ta}(n)$ or $\text{Ca}(n)$ are not trivial. Indeed, these are problems [A011541](#) and [A047696](#) in the *On-Line Encyclopedia of Integer Sequences, OEIS* [6]. Up to now, those known $\text{Ta}(n)$ and $\text{Ca}(n)$ are given in Table 1. Straightforward relations, called *magnifications*, among these values; for example, $\text{Ca}(3) = 2^3 \cdot \text{Ca}(2)$, $\text{Ca}(9) = 5^3 \cdot 67^3 \cdot \text{Ca}(7) = 2^3 \cdot 5^3 \cdot 67^3 \cdot \text{Ca}(6)$ are given in Fig. 1. Magnifications among the best known upper bounds on $\text{Ta}(n)$ and $\text{Ca}(n)$ are described similarly by the diagrams in Figs. 13 and 14 in the Appendix.

$\text{Ta}(n)$	$\text{Ca}(n)$
$\text{Ta}(1) = 2$	$\text{Ca}(1) = 1$
$\text{Ta}(2) = 7 \cdot 13 \cdot 19$	$\text{Ca}(2) = 7 \cdot 13$
$\text{Ta}(3) = 3^3 \cdot 7 \cdot 31 \cdot 67 \cdot 223$	$\text{Ca}(3) = 2^3 \cdot 7 \cdot 13$
$\text{Ta}(4) = 2^{10} \cdot 3^3 \cdot 7 \cdot 13 \cdot 19 \cdot 31 \cdot 37 \cdot 127$	$\text{Ca}(4) = 2^3 \cdot 3^3 \cdot 7^3 \cdot 37$
$\text{Ta}(5) = 2^6 \cdot 3^3 \cdot 7^4 \cdot 13 \cdot 19 \cdot 43 \cdot 73 \cdot 97 \cdot 157$	$\text{Ca}(5) = 3^3 \cdot 7 \cdot 13 \cdot 31 \cdot 79$
$\text{Ta}(6) = 2^6 \cdot 3^3 \cdot 7^4 \cdot 13 \cdot 19 \cdot 43 \cdot 73 \cdot 79^3 \cdot 97 \cdot 157$	$\text{Ca}(6) = 3^3 \cdot 7^4 \cdot 19 \cdot 31 \cdot 37$
	$\text{Ca}(7) = 2^3 \cdot 3^3 \cdot 7^4 \cdot 19 \cdot 31 \cdot 37$
	$\text{Ca}(8) = 2^3 \cdot 3^3 \cdot 7^4 \cdot 19 \cdot 23^3 \cdot 31 \cdot 37$
	$\text{Ca}(9) = 2^3 \cdot 3^3 \cdot 5^3 \cdot 7^4 \cdot 19 \cdot 31 \cdot 37 \cdot 67^3$
	$\text{Ca}(10) = 2^3 \cdot 3^3 \cdot 5^3 \cdot 7^4 \cdot 13^3 \cdot 19 \cdot 31 \cdot 37 \cdot 67^3$

Table 1: Known $\text{Ta}(n)$ and $\text{Ca}(n)$

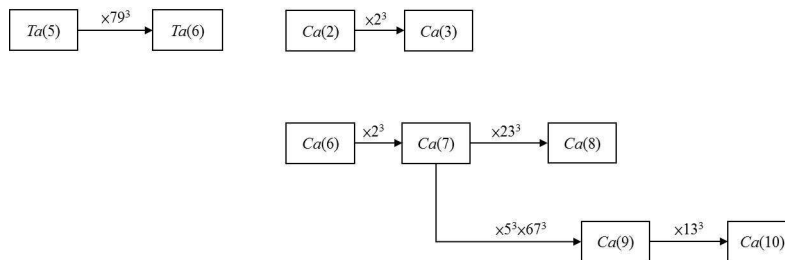

Figure 1: Magnifications among $\text{Ta}(n)$ and $\text{Ca}(n)$

Following the discovery of $\text{Ta}(n)$ with $1 \leq n \leq 6$ and $\text{Ca}(n)$ with $1 \leq n \leq 10$, in 2008, Boyer found upper bounds on $\text{Ta}(7), \dots, \text{Ta}(19)$ and $\text{Ca}(11), \dots, \text{Ca}(30)$ respectively [1, 2]. As mentioned by Boyer later on his webpage, Moore improved the upper bounds on

Ca(11), Ca(12), Ca(14), and Boyer and Wroblewski improved the upper bounds on Ta(11), ..., Ta(19) and Ca(13), Ca(15), ..., Ca(30). Boyer also gave the upper bounds on Ta(20), Ta(21), Ta(22) and Ca(31), ..., Ca(42)[2]. In this paper, the known upper bounds on Ta(n) and Ca(n), given on Boyer's webpage, are denoted by BTa(n) with $7 \leq n \leq 22$, and BCa(n) with $11 \leq n \leq 42$, respectively. Complete decompositions of BTa(n) with $7 \leq n \leq 12$ and BCa(n) with $11 \leq n \leq 22$ can be found in [2].

For given positive integers a and b , a condition for sieving integers $x \geq y$ to satisfy $S = a^3 + b^3 = x^3 + y^3$ is given in Lemma 4. The relation $x + y \equiv a + b \pmod{6}$ is a crucial condition in sieving the upper bounds on Ta(n) and Ca(n). We conjecture that Ta(n) with $n \geq 7$ and Ca(n) with $n \geq 11$ are multiples of 18 (as discussed in Section 3). If $S = a^3 + b^3$ is a multiple of 18, then the introduced *sieving process* can be utilized to find the upper bounds on Ta(n) and Ca(n). Based on the sieving conditions in Theorem 5, together with BTa(n) and BCa(n) that were provided by Boyer, the sieving process is modified herein by applying the concept of floating sieving to reduce the number of computations (Section 4). Applying the floating sieving process, the upper bounds on Ta(23), Ta(24) and Ca(43), ..., Ca(57) together with their corresponding parameters are given in Section 5. The upper bounds on Ta(23), Ta(24), Ca(43) and Ca(44) were collected in *OEIS*, October 2014.

2 Magnifications

Magnification, introduced by Wilson [5] and Boyer [1], is an efficient and frequently used technique for finding the upper bounds on Ta(n) and Ca(n), that is finding a number with $n + 1$ decompositions starting from a number with n decompositions.

2.1 Magnifications among BTa(n) and among BCa(n)

If S can be described in n ways as a sum of two cubes, $S = x_i^3 + y_i^3$ with $i = 1, 2, \dots, n$, and k is an integer, then Sk^3 can be described in at least n ways as a sum of two cubes: $Sk^3 = (kx_i)^3 + (ky_i)^3$ with $i = 1, \dots, n$. If a value k is found such that there exists another sum of two cubes, $Sk^3 = x_{n+1}^3 + y_{n+1}^3$ with $(x_{n+1}, y_{n+1}) \neq (x_i, y_i)$ for $i = 1, 2, \dots, n$, then Sk^3 can be described as $n + 1$ sums of two cubes, yielding an upper bound on Ta($n + 1$) or Ca($n + 1$). Such a number k is called a *splitting factor* by Boyer [1].

For most values of n , the quotient BCa(n)/BCa($n - 1$) or BTa(n)/BTa($n - 1$) is k^3 or the product $k_1^3 \cdot k_2^3$ (where k, k_1 and k_2 are primes). Starting from BTa(7) and BCa(11) on, the quotients BTa(n)/BTa($n - 1$) and BCa(n)/BCa($n - 1$) are given in Table 2 respectively. Some of the quotients are complicated (see below for examples). However, most of them are in a simple form.

1. BTa(11)/BTa(10) = $(2^3 \cdot 5^3 \cdot 13^2 \cdot 17^3 \cdot 31 \cdot 37 \cdot 97^2 \cdot 109^3) / (19 \cdot 29^3 \cdot 101^3 \cdot 127^3)$
2. BCa(11)/BCa(10) = $(2^4 \cdot 3^3 \cdot 37^2 \cdot 43 \cdot 61^3) / (5^3 \cdot 7 \cdot 13^2 \cdot 31 \cdot 67^2)$
3. BCa(13)/BCa(12) = $(2^2 \cdot 3^3 \cdot 7 \cdot 13^3 \cdot 109 \cdot 193) / (19 \cdot 43 \cdot 61^2 \cdot 67)$

4. $\text{BCa}(14)/\text{BCa}(13) = (2^4 \cdot 19 \cdot 31^3 \cdot 43 \cdot 61^2 \cdot 67) / (3^3 \cdot 7 \cdot 13^3 \cdot 109 \cdot 193)$
5. $\text{BCa}(15)/\text{BCa}(14) = (3^3 \cdot 7 \cdot 13^3 \cdot 73^3 \cdot 109 \cdot 193) / (2^4 \cdot 19 \cdot 31^3 \cdot 43 \cdot 61^2 \cdot 67)$
6. $\text{BCa}(19)/\text{BCa}(18) = (5^3 \cdot 11^3 \cdot 37 \cdot 43 \cdot 61^2 \cdot 67^3 \cdot 109^2 \cdot 157) / (2^6 \cdot 13 \cdot 19^6 \cdot 31^2 \cdot 73^2 \cdot 193)$
7. $\text{BCa}(20)/\text{BCa}(19) = (2^6 \cdot 5^3 \cdot 13 \cdot 19^3 \cdot 31^2 \cdot 73^2 \cdot 103^3 \cdot 193) / (11^3 \cdot 37 \cdot 43 \cdot 61^2 \cdot 67^3 \cdot 109^2 \cdot 157)$
8. $\text{BCa}(21)/\text{BCa}(20) = (11^3 \cdot 43 \cdot 61^2 \cdot 67^3 \cdot 79^3 \cdot 109^2 \cdot 157) / (2^6 \cdot 5^3 \cdot 13 \cdot 31^2 \cdot 37^2 \cdot 73^2 \cdot 103^3 \cdot 193)$

(a) BTa(n)		(b) BCa(n)	
n	$\text{BTa}(n)/\text{BTa}(n-1)$	n	$\text{BCa}(n)/\text{BCa}(n-1)$
7	101^3	11	See 2.
8	127^3	12	19^3
9	139^3	13	See 3.
10	$13^3 \cdot 29^3$	14	See 4.
11	See 1.	15	See 5.
12	$3^3 \cdot 19^3$	16	19^3
13	$3^3 \cdot 61^3$	17	$2^6 \cdot 31^3/19^3$
14	397^3	18	19^3
15	503^3	19	See 6.
16	$2^3 \cdot 607^3$	20	See 7.
17	4261^3	21	See 8.
18	$37^3 \cdot 181^3$	22	$37^3/3^3$
19	$5^6 \cdot 457^3 \cdot 521^3/4261^3$	23	3^3
20	4261^3	24	17^3
21	$127^3 \cdot 197^3$	25	$139^3/17^3$
22	$11^3 \cdot 31^3 \cdot 103^3$	26	17^3
		27	5^6
		28	$7^3 \cdot 13^3 \cdot 97^3/5^6 \cdot 17^3$
		29	17^3
		30	5^6
		31	29^3
		32	43^3
		33	181^3
		34	193^3
		35	$397^3 \cdot 457^3/181^3 \cdot 193^3$
		36	181^3
		37	$101^3 \cdot 229^3/181^3$
		38	181^3
		39	163^3
		40	193^3
		41	223^3
		42	307^3

Table 2: Quotients of consecutive $\text{BTa}(n)$ and $\text{BCa}(n)$

The magnifications among $\text{BTa}(7), \dots, \text{BTa}(22)$ and $\text{BCa}(11), \dots, \text{BCa}(42)$ can be found in Figs. 2, 3, 4, 5 and also Figs. 13 and 14 in the Appendix.

2.2 Consecutive magnifications

If k_i with $1 \leq i \leq h$ are splitting factors of S that can be described by n sums of two cubes, such that $k_i^3 S$ can be described by $n+1$ sums of two cubes, then $k_1^3 \cdot k_2^3 \cdots k_h^3 \cdot S$ may be described by $n+h$ sums of two cubes, as in Example 1. The k -th known upper bounds, from small to large, are denoted by $\text{BTa}(n, k)$ and $\text{BCa}(n, k)$ respectively. Some upper bounds on $\text{Ca}(n+h)$ may be improved by applying the magnification technique over some $\text{BCa}(n, k)$, although these are not the best known upper bounds when $k > 1$, as in Examples 2 and 3.

Example 1. $\text{Ta}(6)$ can be described as 6 sums of two cubes; $101^3 \cdot \text{Ta}(6)$ and $127^3 \cdot \text{Ta}(6)$ can be described as 7 sums of two cubes, and $101^3 \cdot 127^3 \cdot \text{Ta}(6)$ can be described as 8 sums

of two cubes. This gives

$$\text{Ta}(8) \leq \text{BTa}(8) = 127^3 \cdot \text{BTa}(7) = 101^3 \cdot 127^3 \cdot \text{Ta}(6).$$

When $k = 23, 29, 38, 43$, each $k^3 \cdot \text{Ca}(10)$ can be described as 11 sums of two cubes, and $23^3 \cdot 29^3 \cdot 38^3 \cdot 43^3 \cdot \text{Ca}(10)$ can be described by 14 sums of two cubes. (see also Examples 6 and 7 in Section 4.1).

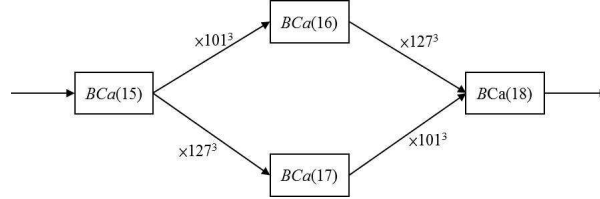

Figure 2: Magnifications among $\text{Ta}(6)$, $\text{BTa}(7)$ and $\text{BTa}(8)$

Example 2. The second and third smallest of the numbers with 9 decompositions are denoted by $\text{BCa}(9, 2)$ and $\text{BCa}(9, 3)$, respectively:

$$\begin{aligned} \text{BCa}(9, 2) &= 2^6 \cdot 3^3 \cdot 7^7 \cdot 19 \cdot 31 \cdot 73 \cdot 97 \cdot 139, \\ \text{BCa}(9, 3) &= 2^7 \cdot 3^6 \cdot 7^3 \cdot 13 \cdot 19 \cdot 37^3 \cdot 43 \cdot 67. \end{aligned}$$

The upper bounds on $\text{Ca}(11)$ that were derived by Boyer and Moore in 2008 are

$$\begin{aligned} \text{Ca}(11) &\leq 13^3 \cdot 17^3 \cdot \text{BCa}(9, 2), \text{ and} \\ \text{BCa}(11) &\leq 61^3 \cdot \text{BCa}(9, 3) \end{aligned}$$

respectively. Although $\text{BCa}(9, 3)$ is larger than $\text{BCa}(9, 2)$, we have

$$\text{Ca}(11) \leq \text{BCa}(11) = 61^3 \cdot \text{BCa}(9, 3) < 13^3 \cdot 17^3 \cdot \text{BCa}(9, 2).$$

Fig. 3 presents the magnifications among the best known bounds.

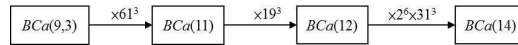

Figure 3: $\text{BCa}(11)$, $\text{BCa}(12)$, $\text{BCa}(14)$ associated with $\text{BCa}(9, 3)$

Example 3. The fifth smallest known with 10 decompositions is

$$\text{BCa}(10, 5) = 2^9 \cdot 3^3 \cdot 7^4 \cdot 13^4 \cdot 19^3 \cdot 61 \cdot 109 \cdot 193.$$

The upper bounds associated with $\text{BCa}(10, 5)$ are given below:

$$\begin{aligned}
\text{BCa}(13) &= 3^6 \cdot 37^3 \cdot \text{BCa}(10, 5), \\
\text{BCa}(15) &= 3^6 \cdot 37^3 \cdot 73^3 \cdot \text{BCa}(10, 5) = 73^3 \cdot \text{BCa}(13), \\
\text{BCa}(16) &= 3^6 \cdot 19^3 \cdot 37^3 \cdot 73^3 \cdot \text{BCa}(10, 5) = 19^3 \cdot \text{BCa}(15), \\
\text{BCa}(17) &= 2^6 \cdot 3^6 \cdot 31^3 \cdot 37^3 \cdot 73^3 \cdot \text{BCa}(10, 5) = 2^6 \cdot 31^3 \cdot \text{BCa}(15), \\
\text{BCa}(18) &= 2^6 \cdot 3^6 \cdot 19^3 \cdot 31^3 \cdot 37^3 \cdot 73^3 \cdot \text{BCa}(10, 5) = 19^3 \cdot \text{BCa}(17), \\
\text{BCa}(20) &= 2^6 \cdot 3^6 \cdot 5^6 \cdot 31^3 \cdot 37^3 \cdot 73^3 \cdot 103^3 \cdot \text{BCa}(10, 5) = 2^6 \cdot 5^6 \cdot 31^3 \cdot 103^3 \cdot \text{BCa}(15),
\end{aligned}$$

which are summarized in Fig. 4.

In Fig. 5, the magnifications among $\text{BCa}(15)$, $\text{BCa}(16)$, $\text{BCa}(17)$ and $\text{BCa}(18)$ are displayed in the shape of a parallelogram. Similar situations also hold in $\text{BCa}(23)$, $\text{BCa}(24)$, $\text{BCa}(25)$ and $\text{BCa}(26)$, as displayed in Fig. 7, and $\text{BCa}(35)$, $\text{BCa}(36)$, $\text{BCa}(37)$, $\text{BCa}(38)$, as displayed in Fig. 9, respectively.

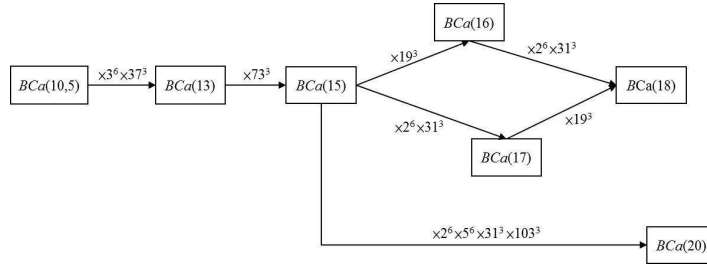

Figure 4: $\text{BCa}(n)$ associated with $\text{BCa}(10, 5)$

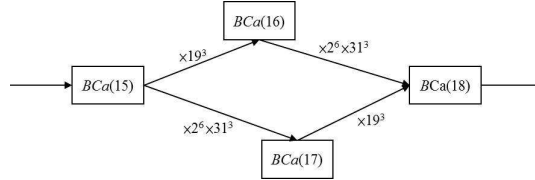

Figure 5: Magnifications among $\text{BCa}(15)$, $\text{BCa}(16)$, $\text{BCa}(17)$, $\text{BCa}(18)$

3 Parameters of decompositions

If $S = a^3 + b^3$, then $a^3 + b^3$ is called a decomposition of S as a sum of two cubes, abbreviated as a *decomposition* of S . Hence $\text{Ta}(n)$ (resp., $\text{Ca}(n)$) is the smallest positive integer with n decompositions with nonnegative integral summands (or respectively integral summands). We will show that each decomposition of S can be expressed as a parametric function; see Theorem 5.

3.1 Decompositions as sums of two cubes

Consider decompositions $S = x_1^3 + y_1^3 = x_2^3 + y_2^3$ as sums of two cubes, and observe that $(x_1 + y_1) - (x_2 + y_2)$ is a multiple of 6 in Table 3, and will be proved in Lemma 4.

S	x_1	y_1	x_2	y_2	$(x_1 + y_1) - (x_2 + y_2)$
1,729	10	9	12	1	6
4,104	15	9	16	2	6
20,683	24	19	27	10	6
39,312	33	15	34	2	12
40,033	33	16	34	9	6
65,728	33	31	40	12	12
64,232	36	26	39	17	6
134,379	43	38	51	12	18
149,389	50	29	53	8	18
171,288	54	24	55	17	6

Table 3: Relations between pairs of decompositions

Lemma 4. For integers a, b, x, y with $a < x$ and $a^3 + b^3 = x^3 + y^3$, then

$$x + y \equiv a + b \pmod{6}.$$

Proof. We notice that $a^3 - a = (a - 1)a(a + 1)$ is a multiple of 6, and then $a^3 \equiv a \pmod{6}$ holds for any integer a . Hence, $x + y \equiv a + b \pmod{6}$. \square

Based on observations on known $\text{Ta}(n)$ with $n = 4, 5, 6$, $\text{BTa}(n)$ with $7 \leq n \leq 12$, $\text{Ca}(n)$ with $7 \leq n \leq 10$, and $\text{BCa}(n)$ with $11 \leq n \leq 22$, note that $6|(x + y)$ in each decomposition $S = x^3 + y^3$ and therefore $x^3 + y^3$ is a multiple of 18 because of $x^3 + y^3 = (x + y)((x + y)^2 - 3xy)$. We conjecture that $\text{Ta}(n)$ with $n \geq 7$ and $\text{Ca}(n)$ with $n \geq 11$ are all multiples of 18. This is because when the magnification technique is used to find the upper bound on $\text{Ta}(n + 1)$ and $\text{Ca}(n + 1)$ from $\text{BTa}(n)$ and $\text{BCa}(n)$ of multiples of 18, the one derived will also be a multiple of 18. Section 4 introduces the sieving process that can be used to find the upper bounds on $\text{Ta}(n)$ and $\text{Ca}(n)$.

3.2 Parameters of decompositions

All sums of two cubes can be expressed as a parametric function (see Theorem 5), and this fact leads to a sieving process in Section 4.

For a given $S = a^3 + b^3$ with positive integers $a \geq b$, to determine integers $x \geq y$ such that $S = a^3 + b^3 = x^3 + y^3$, $k = x + y$ is introduced and x, y must be obtained for appropriate k (or else may have no solution).

$$\begin{cases} x + y = k, \\ x^3 + y^3 = S. \end{cases}$$

Hence, $x = x(k, S)$ and $y = y(k, S)$ can be expressed as functions of k and S . Substituting $y = k - x$ into $x^3 + (k - x)^3 = S$ yields $3x^2 - 3kx + (k^3 - S)/k = 0$ and therefore,

$$x = (3k + \sqrt{(3k)^2 - 4 \cdot 3 \cdot (k^3 - S)/k})/6,$$

$$y = (3k - \sqrt{(3k)^2 - 4 \cdot 3 \cdot (k^3 - S)/k})/6.$$

The necessary and sufficient condition for x and y to be positive integers is that the expression $-3k^2 + 12S/k \geq 0$ inside the square root is a perfect square. Since $-3k^2 + 12S/k \geq 0$ and $k^3 = (x + y)^3 > x^3 + y^3 = S$, we then have $\sqrt[3]{S} < k \leq \sqrt[3]{4S}$.

Repeating the above for $k = x + y = 6r$ yields $x^2 - 6rx + 12r^2 - S/18r = 0$. Substituting $y = 6r - x$ yields

$$x = 3r + \sqrt{-3r^2 + (S/18r)},$$

$$y = 3r - \sqrt{-3r^2 + (S/18r)}.$$

The necessary and sufficient condition for x and y to be positive integers is that $-3r^2 + S/18r$ is a perfect square. Moreover, $\sqrt[3]{S/216} < r \leq \sqrt[3]{S/54}$ because $-3r^2 + S/18r \geq 0$ and $(6r)^3 = (x + y)^3 > x^3 + y^3 = S$. The above is summarized as follows:

Theorem 5. *If $S = x^3 + y^3, x + y = k$ and $x \geq y$, then*

$$x = \frac{3k + \sqrt{-3k^2 + 12S/k}}{6}, y = \frac{3k - \sqrt{-3k^2 + 12S/k}}{6}.$$

Moreover,

(a) $x = \frac{3k + \sqrt{-3k^2 + 12S/k}}{6}$ and $y = \frac{3k - \sqrt{-3k^2 + 12S/k}}{6}$ are positive rationals if and only if $k|S$, $\sqrt[3]{S} < k \leq \sqrt[3]{4S}$, and $-3r^2 + 12S/k$ are perfect squares.

(b) When $k = 6r$, $x = 3r + \sqrt{-3r^2 + (S/18r)}$ and $y = 3r - \sqrt{-3r^2 + (S/18r)}$ are positive integers if and only if $18|S$, r is a divisor of $S/18$, $\sqrt[3]{S/216} < r \leq \sqrt[3]{S/54}$ and $-3r^2 + (S/18r)$ is a perfect square.

Among the sieving conditions in Theorem 5, the condition of perfect square is most crucial, as shown in Examples 6 and 7. The condition that r is a factor of $S/18$ is required in the Sieving Process and floating sieving process. When n parameters $r = r_1, r_2, \dots, r_n$ are sieved, then the parametric functions

$$r_i \rightarrow (x_i, y_i) = (x(r_i), y(r_i))$$

provides n decompositions of $S = (x(r_i))^3 + (y(r_i))^3$ with $1 \leq i \leq n$.

4 Sieving and floating sieving

Based on the parametric expression given in Theorem 5, a sieving process for upper bounds on $Ta(n)$ and $Ca(n)$ is given in Section 4.1. Upper bounds on $Ta(n)$ with $n = 7, 8, 9$ and on $Ca(n)$ with $n = 11, \dots, 16$, derived by this process are given in Examples 6, 7 and 8 with illustrations. To reduce computational load, the floating sieving process is introduced in Section 4.2 with illustrations by applying the concept of floating sieving.

4.1 Sieving process

For given integers a and b , the conditions that govern the parameters given in Theorem 5 can be used to sieve for possible integers x, y that satisfy $S = a^3 + b^3 = x^3 + y^3$, providing a means of exploring upper bounds on $Ta(n)$ and $Ca(n)$ respectively.

Sieving process

1. Input $S = a^3 + b^3$ and k , let *counter* = 0.
2. List all positive factors $r_1 < r_2 < r_3 \cdots < r_t$ of $Sk^3/18$.
3. For $i = 1, \dots, t$,
 If $\sqrt[3]{Sk^3/216} < r_i \leq \sqrt[3]{Sk^3/54}$,
 If $-3r_i^2 + Sk^3/18r_i$ is a perfect square,
 output $r_i, x(r_i) = 3r_i + \sqrt{-3r_i^2 + Sk^3/18r_i}$ and $y(r_i) = 3r_i - \sqrt{-3r_i^2 + Sk^3/18r_i}$.
 counter \leftarrow *counter* + 1, $i \leftarrow i + 1$, return to Step 3.
 otherwise $i \leftarrow i + 1$, return to Step 3.
 Otherwise, $i \leftarrow i + 1$, return to Step 3.
4. Output *counter*.

Let $S = a^3 + b^3$. To find x, y with $Sk^3 = x^3 + y^3$, the function *counter* gives the number of decompositions, it is more likely to increase for prime k . If the condition $\sqrt[3]{Sk^3/216} < r \leq \sqrt[3]{Sk^3/54}$ above is replaced by $0 < r \leq \sqrt[3]{Sk^3/54}$, then all integral solutions of $Sk^3 = k^3(a^3 + b^3) = x^3 + y^3$ can be derived, yielding a sieving process for Cabtaxi numbers. In the following examples, the sieving process is illustrated in terms of $Ta(6)$ with $k = 101, 127$ and $Ca(10)$ with $k = 23, 29, 38, 43, 127$.

Example 6. For $S = Ta(6) = 2^6 \cdot 3^3 \cdot 7^4 \cdot 13 \cdot 19 \cdot 43 \cdot 73 \cdot 79^3 \cdot 97 \cdot 157$ and $k = 101$, Sk^3 has 143,360 positive factors, of the 61,440 positive factors of $Sk^3/18$, 629 lie between $\sqrt[3]{Sk^3/216}$ and $\sqrt[3]{Sk^3/54}$, and finally $-3r^2 + Sk^3/18r$ is a perfect square for only 7 of them. Therefore, 7 decompositions are derived by using Theorem 5, yielding $Ta(7) \leq 101^3 \cdot Ta(6)$.

Example 7. For $S = Ta(6) \cdot 101^3 = 2^6 \cdot 3^3 \cdot 7^4 \cdot 13 \cdot 19 \cdot 43 \cdot 73 \cdot 79^3 \cdot 97 \cdot 101^3 \cdot 157$ and $k = 127$, Sk^3 has 573,440 factors, of the 245,760 positive factors of $Sk^3/18$, 2,004 lie between $\sqrt[3]{Sk^3/216}$ and $\sqrt[3]{Sk^3/54}$, and finally $-3r^2 + Sk^3/18r$ is a perfect square for only 8 of them. Therefore, 8 decompositions are derived by using Theorem 5, yielding

$$Ta(8) \leq 101^3 \cdot 127^3 \cdot Ta(6).$$

Notably, the numbers 101 and 127 above are primes, and $counter = 9$ is derived for $101^3 \cdot 127^3 \cdot 139^3 \cdot Ta(6)$, which therefore has 9 decompositions, so

$$Ta(9) \leq 101^3 \cdot 127^3 \cdot 139^3 \cdot Ta(6).$$

Example 8. For $S = Ca(10)$, then $counter = 11$ is derived when $k = 23, 29, 38, 43$ and 46 . Moreover, each of $23^3 \cdot Ca(10)$, $23^3 \cdot 29^3 \cdot Ca(10)$, $23^3 \cdot 29^3 \cdot 38^3 \cdot Ca(10)$, and $23^3 \cdot 29^3 \cdot 38^3 \cdot 43^3 \cdot Ca(10)$ have 11, 12, 13 and 14 parameters respectively. The above bounds on $Ca(12)$, $Ca(13)$, $Ca(14)$ can be improved further. Consider the prime $k = 127 \leq 23 \cdot 29$, for which $counter = 12$, meaning that $127^3 \cdot Ca(10)$ also has 12 parameters, a better bound, so

$$Ca(12) \leq 127^3 \cdot Ca(10).$$

Similar arguments show that

- $29^3 \cdot 127^3 \cdot Ca(10)$ has 13 parameters, an upper bound of $Ca(13)$,
- $29^3 \cdot 43^3 \cdot 127^3 \cdot Ca(10)$ has 14 parameters, an upper bound of $Ca(14)$,
- $23^3 \cdot 29^3 \cdot 38^3 \cdot 127^3 \cdot Ca(10)$ has 15 parameters, an upper bound of $Ca(15)$,
- $23^3 \cdot 29^3 \cdot 38^3 \cdot 43^3 \cdot 127^3 \cdot Ca(10)$ has 16 parameters, an upper bound of $Ca(16)$.

We let $SCa(11), \dots, SCa(16)$ denote the upper bounds on $Ca(11), \dots, Ca(16)$ obtained by sieving process based on $Ca(10)$. These bounds are summarized below for reference, though they are not as good as bounds given by Boyer. The magnifications among them are given in Fig. 6. The same technique can also be used to derive upper bounds on $Ca(43), \dots, Ca(57)$ based on $BCa(42)$; see Theorem 11, and upper bounds on $Ta(23), Ta(24)$ based on $BTa(22)$ as well; see Theorem 12.

$$\begin{aligned} Ca(11) &\leq BCa(11) \leq SCa(11) = 23^3 \cdot Ca(10) \\ &= 2^3 \cdot 3^3 \cdot 5^3 \cdot 7^4 \cdot 13^3 \cdot 19 \cdot 23^3 \cdot 31 \cdot 37 \cdot 67^3, \\ Ca(12) &\leq BCa(12) \leq SCa(12) = 127^3 \cdot Ca(10) \\ &= 2^3 \cdot 3^3 \cdot 5^3 \cdot 7^4 \cdot 13^3 \cdot 19 \cdot 31 \cdot 37 \cdot 67^3 \cdot 127^3, \\ Ca(13) &\leq BCa(13) \leq SCa(13) = 29^3 \cdot 127^3 \cdot Ca(10) \\ &= 2^3 \cdot 3^3 \cdot 5^3 \cdot 7^4 \cdot 13^3 \cdot 19 \cdot 29^3 \cdot 31 \cdot 37 \cdot 67^3 \cdot 127^3, \\ Ca(14) &\leq BCa(14) \leq SCa(14) = 29^3 \cdot 43^3 \cdot 127^3 \cdot Ca(10) \\ &= 2^3 \cdot 3^3 \cdot 5^3 \cdot 7^4 \cdot 13^3 \cdot 19 \cdot 29^3 \cdot 31 \cdot 37 \cdot 43^3 \cdot 67^3 \cdot 127^3, \\ Ca(15) &\leq BCa(15) \leq SCa(15) = 2^3 \cdot 19^3 \cdot 23^3 \cdot 29^3 \cdot 127^3 \cdot Ca(10) \\ &= 2^6 \cdot 3^3 \cdot 5^3 \cdot 7^4 \cdot 13^3 \cdot 19^4 \cdot 23^3 \cdot 29^3 \cdot 31 \cdot 37 \cdot 67^3 \cdot 127^3, \\ Ca(16) &\leq BCa(16) \leq SCa(16) = 2^3 \cdot 19^3 \cdot 23^3 \cdot 29^3 \cdot 43^3 \cdot 127^3 \cdot Ca(10) \\ &= 2^6 \cdot 3^3 \cdot 5^3 \cdot 7^4 \cdot 13^3 \cdot 19^4 \cdot 23^3 \cdot 29^3 \cdot 31 \cdot 37 \cdot 43^3 \cdot 67^3 \cdot 127^3. \end{aligned}$$

4.2 Floating sieving process

Upper bounds for $Ta(7), Ta(8), Ta(9)$, and for $Ca(11), \dots, Ca(16)$ were derived by the above sieving process. However, the computing time that is needed for sieving increases as an

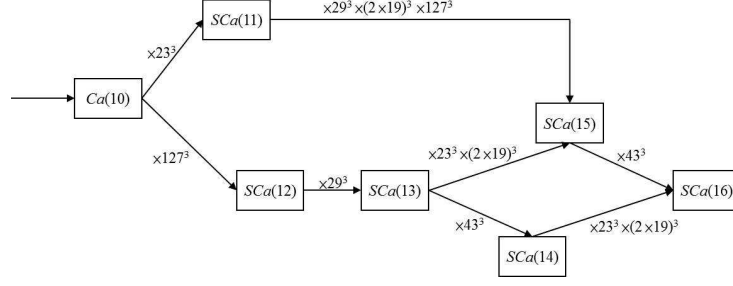

Figure 6: Magnifications among $Ca(10), SCa(11), \dots, SCa(16)$

exponential function of n in both $Ca(n)$ and $Ta(n)$. The process is therefore modified by considering the exponent sum of its standard factorization, rather than a value itself, and this modified process is called *floating sieving process*.

Recall that each parameter r is a divisor of $S/18$ as shown in Theorem 5. Let $r_i = \prod_{j=1}^m p_j^{\beta_{i,j}}$

for primes $p_1 < p_2 < \dots < p_m$ with $1 \leq i \leq n$ be the standard product of prime powers of the parameter of $BCa(n)$, abbreviated as $r_i = (\beta_{i,1}, \beta_{i,2}, \dots, \beta_{i,m})$ with base (p_1, p_2, \dots, p_m) . When a number S that can be described as $n + 1$ sums of two cubes, we may try $S = k^3 \cdot BCa(n)$ first for a splitting factor k . Since $S = k^3 \cdot BCa(n)$ itself already has n decompositions with parameters kr_1, kr_2, \dots, kr_n , the key lies in finding an *additional parameter* r_{n+1} . Let $a_i = \sum_{j=1}^m \beta_{i,j}$ with $1 \leq i \leq n$ be the exponent sum of r_i , and let $[L, U]$ be an interval that contains all a_i . Based on the assumption that k is a prime, the exponent sums of kr_1, kr_2, \dots, kr_n lie in the interval $[L+1, U+1]$. The exponent-sums of additional parameters are likely in the interval $[L+1, U+1]$ as well, rather than in the range of the parameter $[\sqrt[3]{S/216}, \sqrt[3]{S/54}]$ so many and huge numbers can be avoided.

More specifically, an additional parameter $r_{n+1} = k^{\beta_{m+1}} \cdot \prod_{i=1}^m p_i^{\beta_i}$, associated with

$k^3 \cdot BCa(n) = k^3 \cdot \prod_{i=1}^m p_i^{\alpha_i}$, may satisfy the conditions $0 \leq \beta_1 \leq \alpha_1 - 1$, $0 \leq \beta_2 \leq \alpha_2 - 2$ (since $18 = 2 \cdot 3^2$ is a divisor of S), $0 \leq \beta_i \leq \alpha_i/2$ with $3 \leq i \leq m$, and $\beta_{m+1} = 0$ or 3 . Based on a comparison with original sieving over all $(\beta_1, \beta_2, \dots, \beta_{m+1})$ for $0 \leq \beta_i \leq \alpha_i$ with $i \leq m$, and $0 \leq \beta_{m+1} \leq 3$, only restricted values of r are sieved for, efficiently reducing the time needed for sieving. Therefore, the number of searches will be reduced to about $1/2^{m+1}$ of the original number, where m is the number of prime factors in the standard factorization of $BCa(n)$.

Floating sieving process

1. Input primes $\{p_i\}$ and nonnegative integers $\{\alpha_i\}$ with $1 \leq i \leq m$ with $(p_1, p_2) = (2, 3)$

(for $\text{BCa}(n) = \prod_{i=1}^m p_i^{\alpha_i}$), k (for magnification $S = k^3 \cdot \prod_{i=1}^m p_i^{\alpha_i}$), and L, U (range for scanning).

2. Input β_i with $i = 1, \dots, m+1$, where $0 \leq \beta_1 \leq \alpha_1 - 1$, $0 \leq \beta_2 \leq \alpha_2 - 2$, $0 \leq \beta_i \leq \alpha_i/2$, $i = 3, \dots, m$, and $\beta_{m+1} = 0, 3$. (candidates for scanning)
3. For each sequence $(\beta_1, \beta_2, \dots, \beta_{m+1})$, let $r = k^{\beta_{m+1}} \cdot \prod_{i=1}^m p_i^{\beta_i}$, and $a = \sum_{i=1}^{m+1} \beta_i$.
4. If $L \leq a \leq U$,
if $-3r^2 + S/18r$ is a perfect square,
output r , $x(r) = 3r + \sqrt{-3r^2 + S/18r}$, and $y = 3r - \sqrt{-3r^2 + S/18r}$,
return to Step 3.
otherwise, return to Step 3.
Otherwise, return to Step 3.

The choices of L , U and β_i are crucial in floating sieving for upper bounds, as properly chosen values greatly reduce the number of computations. A risk of missing searching targets is taken; however, it is still worthwhile if performance efficiency is taken into consideration.

Example 9. Based on the floating sieving process, sets of parameters for $\text{BCa}(22)$, $\text{BCa}(30)$, $\text{BCa}(42)$ and $\text{BTa}(22)$ are given in Tables 8–12 in the Appendix. The first rows of these tables present the bases (p_1, p_2, \dots, p_m) . The magnifications among $\text{BCa}(23), \dots, \text{BCa}(26)$ are summarized in Table 4 with the base $(p_1, p_2, \dots, p_{18}) = (2, 3, 5, 7, 11, 13, 17, 19, 31, 37, 43, 61, 67, 73, 79, 109, 139, 157)$, and the parameters for $\text{BCa}(23), \dots, \text{BCa}(26)$ are thus provided.

$\text{BCa}(n)$	<i>additional parameters</i>
$\text{BCa}(23)$ = $3^3 \cdot \text{BCa}(22)$	$r_{23} = (6, 7, 1, 1, 1, 1, 0, 1, 1, 1, 0, 0, 1, 0, 1, 1, 0, 0)$
$\text{BCa}(24)$ = $17^3 \cdot \text{BCa}(23)$	$r_{24} = (2, 2, 1, 2, 1, 1, 3, 1, 0, 1, 0, 1, 1, 0, 1, 1, 0, 0)$
$\text{BCa}(25)$ = $139^3 \cdot \text{BCa}(23)$	$r'_{24} = (2, 2, 3, 2, 1, 1, 0, 1, 1, 1, 1, 1, 1, 0, 1, 1, 0, 0)$ $r_{25} = (4, 2, 3, 1, 1, 1, 0, 1, 0, 1, 1, 1, 1, 1, 1, 1, 0, 0)$
$\text{BCa}(26)$ = $139^3 \cdot \text{BCa}(24)$ = $17^3 \cdot \text{BCa}(25)$	$139 \cdot r_{24}$ $17 \cdot r'_{24}$ $17 \cdot r'_{25}$

Table 4: Parameters of $\text{BCa}(23)$, $\text{BCa}(24)$, $\text{BCa}(25)$, $\text{BCa}(26)$

5 Upper bounds on $\text{Ca}(43), \dots, \text{Ca}(57)$, and $\text{Ta}(23)$, $\text{Ta}(24)$

To find an additional parameter of an upper bound on $\text{Ca}(43)$ starting from $\text{BCa}(42)$ by using sieving process, too much computations are required because $\text{BCa}(42)$ has 29 prime

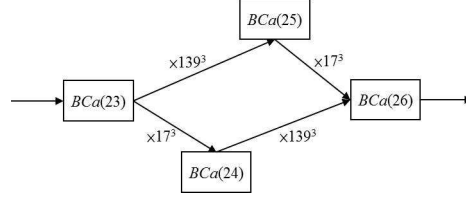

Figure 7: Magnifications among BCa(23), BCa(24), BCa(25), BCa(26)

factors. On the other hand, a value k can be a splitting factor of BCa(n) as well as of BCa($n + h$) simultaneously, splitting factors of BCa(30), rather than of BCa(42), tend to be sought because BCa(30) has 19 prime factors.

First, the parameters for BCa(31), BCa(32), BCa(35), BCa(37), BCa(38), \dots , and finally BCa(42) are obtained by a sequence of consecutive magnifications (Table 5). Then 15 splitting factors of BCa(30), either primes or products of two primes, are provided along with their additional parameters, as in Table 6. Combining these 15 splitting factors of BCa(30) and the 42 parameters for BCa(42) enables an upper bound on Ca(43) to be derived. In addition to an upper bound on Ca(43), upper bounds on Ca(44), \dots , Ca(57) can be derived in terms of the magnifications

$$\text{BCa}(42) = Q^3 \cdot \text{BCa}(30) \text{ and } k^3 \cdot \text{BCa}(42) = k^3 \cdot Q^3 \cdot \text{BCa}(30)$$

with respect to specific splitting factor k of BCa(30), as in Figs. 10 and 11. A similar technique can be used to the derive of upper bounds on Ta(23) and Ta(24) from BTa(12) as in Section 5.3.

5.1 The set of 42 parameters of BCa(42)

The set of 30 parameters of

$$\text{BCa}(30) = 2^9 \cdot 3^9 \cdot 5^9 \cdot 7^7 \cdot 11^3 \cdot 13^6 \cdot 17^3 \cdot 19^3 \cdot 31^1 \cdot 37^4 \cdot 43^1 \cdot 61^3 \cdot 67^3 \cdot 73^1 \cdot 79^3 \cdot 97^3 \cdot 109^3 \cdot 139^3 \cdot 157^1$$

is given in Table 9, which yields 30 decompositions. A sequence of magnifications of BCa(31), BCa(32), BCa(35), BCa(37), \dots , BCa(42), as shown in Fig. 8, follows, and Table 5 presents their corresponding additional parameters. Notably the base

$$\begin{aligned} & (p_1, p_2, \dots, p_{29}) \\ = & (2, 3, 5, 7, 11, 13, 17, 19, 29, 31, 37, 43, 61, 67, 73, 79, 97, \\ & 101, 109, 139, 157, 163, 181, 193, 223, 229, 307, 397, 457). \end{aligned}$$

The set of 42 parameters of BCa(42) is given in Tables 10 and 11 with bases $(p_1, p_2, \dots, p_{29})$ in the first rows in the Appendix.

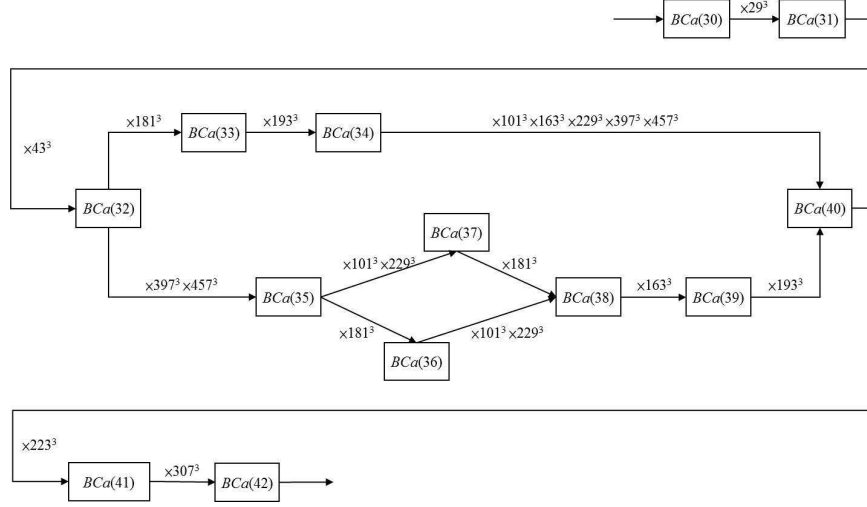

Figure 8: Magnifications among BCa(30), BCa(31), BCa(32), BCa(35), BCa(37), . . . , BCa(42)

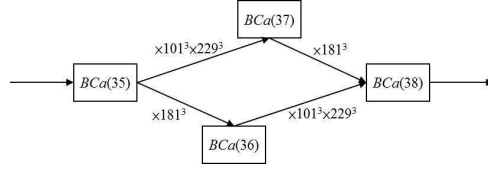

Figure 9: Magnifications among BCa(35), BCa(36), BCa(37), BCa(38)

5.2 Upper bounds on Ca(43), . . . , Ca(57)

Upper bounds on Ca(43) can be derived by a two-step strategy as follows:

1. Find a sequence of magnifications of BCa(30), . . . , BCa(42) (Table 5).
2. Find 15 splitting factors of BCa(30) by floating sieving (Table 6),

starting from BCa(30), and then upper bounds on Ca(44), . . . , Ca(55) are derived in a sequence of magnifications.

Floating sieving process is used to find splitting factors k of BCa(30) with additional parameter R . Let $\text{BCa}(30) = \prod_{i=1}^{19} p_i^{\alpha_i}$, and the corresponding 30 parameters of r_i be $\prod_{j=1}^{19} p_j^{\beta_{i,j}}$.

Additional parameter $R = k^{\beta_{20}} \cdot \prod_{i=1}^{19} p_i^{\beta_i}$, whose possible β_i , $i = 1, \dots, 19$ are summarized in Table 7, with $\beta_{20} = 0$ or 3, can be found in the following.

BCa(n)	<i>additional parameters</i>
BCa(31) = $29^3 \cdot \text{BCa}(30)$	$r_{31} = (2, 2, 3, 2, 1, 2, 1, 1, 3, 0, 1, 0, 1, 1, 0, 1, 1, 0, 0, 0, 0, 0, 0, 0, 0, 0, 0)$
BCa(32) = $43^3 \cdot \text{BCa}(31)$	$r_{32} = (2, 3, 5, 2, 1, 2, 1, 1, 3, 0, 1, 0, 1, 1, 0, 1, 1, 0, 0, 0, 0, 0, 0, 0, 0, 0, 0)$
BCa(35) = $397^3 \cdot 457^3 \cdot \text{BCa}(32)$	$r_{33} = (2, 2, 9, 2, 1, 2, 1, 1, 1, 0, 1, 1, 1, 1, 1, 1, 0, 1, 1, 0, 0, 0, 0, 0, 0, 0, 1, 0)$ $r_{34} = (2, 5, 3, 1, 1, 2, 1, 1, 1, 1, 1, 2, 1, 1, 0, 1, 1, 0, 1, 1, 1, 0, 0, 0, 0, 0, 0, 1)$ $r_{35} = (4, 2, 7, 3, 1, 2, 1, 1, 1, 1, 2, 1, 1, 1, 0, 1, 1, 0, 1, 1, 0, 0, 0, 0, 0, 0, 0, 0)$
BCa(37) = $101^3 \cdot 229^3 \cdot \text{BCa}(35)$	$r_{36} = (4, 2, 3, 0, 1, 2, 1, 1, 1, 0, 1, 1, 1, 1, 0, 1, 1, 3, 1, 1, 1, 0, 0, 0, 0, 0, 0, 1, 1)$ $r_{37} = (6, 3, 3, 5, 1, 2, 1, 1, 1, 0, 2, 1, 1, 1, 1, 1, 1, 1, 1, 0, 0, 0, 0, 0, 0, 0, 0, 1)$
BCa(38) = $181^3 \cdot \text{BCa}(37)$	$r_{38} = (2, 5, 5, 3, 1, 2, 1, 1, 1, 1, 0, 1, 1, 1, 1, 1, 1, 1, 1, 0, 0, 0, 0, 0, 1, 0, 1, 1)$
BCa(39) = $163^3 \cdot \text{BCa}(38)$	$r_{39} = (2, 2, 3, 5, 1, 2, 1, 0, 1, 0, 1, 1, 1, 1, 0, 1, 1, 1, 1, 1, 3, 0, 0, 0, 1, 0, 0, 1)$
BCa(40) = $193^3 \cdot \text{BCa}(39)$	$r_{40} = (2, 2, 3, 2, 1, 2, 1, 1, 1, 0, 1, 2, 1, 1, 0, 1, 1, 1, 1, 1, 1, 1, 0, 0, 1, 0, 1, 1)$
BCa(41) = $223^3 \cdot \text{BCa}(40)$	$r_{41} = (6, 3, 3, 2, 1, 2, 1, 1, 1, 0, 1, 1, 1, 1, 0, 1, 1, 1, 1, 1, 1, 1, 0, 1, 0, 1, 0, 1, 1)$
BCa(42) = $307^3 \cdot \text{BCa}(41)$	$r_{42} = (2, 3, 3, 2, 1, 2, 1, 1, 1, 0, 1, 1, 1, 1, 0, 1, 1, 1, 1, 0, 1, 1, 1, 1, 0, 3, 1, 1)$

Table 5: Magnifications of BCa(30) and their additional parameters

The exponent-sums $\sum_{j=1}^{19} \beta_{i,j}$, $1 \leq i \leq 30$, of the set of 30 parameters

$r_i = \prod_{j=1}^{19} p_j^{\beta_{i,j}}$ of BCa(30) lie in the interval $[21, 30]$. Set $L = 22$ and $U = 31$. Floating sieving is performed using possible values of $\beta_1, \dots, \beta_{19}$ that are shown in Table 7, and $\beta_{20} = 0$ or 3. Calculate $r = k^{\beta_{20}} \cdot \prod_{i=1}^{20} p_i^{\beta_i}$ whenever $22 \leq \sum_{i=1}^{20} \beta_i \leq 31$. Moreover, if $-3r^2 + k^3 \cdot \text{BCa}(30)/18r$ is a perfect square, then this r is an additional parameter, denoted by R , of $k^3 \cdot \text{BCa}(30)$. It follows that 15 splitting factors in the form of a prime or a product of two primes of BCa(30), together with their additional parameters are given in Table 6 with the base

$$\begin{aligned}
 & (p_1, p_2, \dots, p_{22}) \\
 &= (2, 3, 5, 7, 11, 13, 17, 19, 23, 31, 37, 43, 61, 67, 73, 79, 97, 109, 139, 157, 503, 1307)
 \end{aligned}$$

We then show that upper bound on Ca(43) can be derived from a sequence of magnifications BCa(30), BCa(31), BCa(32), BCa(35), BCa(36), BCa(38), \dots , BCa(42). Let r_i , $i = 1, \dots, 42$, be the set of parameters of BCa(42) and let

$$\begin{aligned}
 Q &= 29 \cdot 43 \cdot (397 \cdot 457) \cdot 181 \cdot (101 \cdot 229) \cdot 163 \cdot 193 \cdot 223 \cdot 307 \\
 &= 29 \cdot 43 \cdot 101 \cdot 163 \cdot 181 \cdot 193 \cdot 223 \cdot 229 \cdot 307 \cdot 397 \cdot 457,
 \end{aligned}$$

as presented in Fig. 10. Then the magnification $\text{BCa}(42) = Q^3 \cdot \text{BCa}(30)$ holds. If k_j is a splitting factor of BCa(30), relative prime with Q , and $k_j^3 \cdot \text{BCa}(30)$ has an additional

i	splitting factors k_i	additional parameters R
1	487	(4,5,3,2,1,2,1,0,0,1,1,0,1,1,0,1,1,1,0,0,0)
2	503	(2,2,3,1,1,2,1,0,0,0,1,0,1,1,0,1,1,1,0,3,0)
3	$2 \cdot 607$	(11,2,3,2,1,2,1,1,0,1,1,0,0,1,1,1,1,1,1,0,0)
4	1307	(2,2,3,2,1,2,1,1,0,0,1,0,1,0,0,1,0,1,1,0,0,3)
5	$31 \cdot 103$	(2,3,3,3,3,2,1,1,0,0,1,1,1,1,1,1,1,1,0,0,0)
6	3559	(2,7,3,3,1,2,1,1,0,1,1,0,1,1,1,1,1,1,0,0,0)
7	4057	(2,2,5,2,1,2,1,0,0,0,2,0,1,1,1,1,1,1,1,0,0)
8	4261	(4,2,3,3,1,2,1,1,0,0,2,1,1,0,1,1,1,1,1,0,0)
9	4339	(4,2,3,2,1,2,1,1,0,1,1,0,1,1,1,1,1,1,1,0,0)
10	4957	(2,5,3,2,1,2,1,1,0,1,1,1,1,0,1,1,1,1,1,0,0)
11	$23 \cdot 283$	(2,3,3,1,1,2,1,1,3,0,2,1,1,1,0,1,1,1,1,0,0,0)
12	6661	(2,2,3,2,1,2,1,1,0,1,2,1,1,1,1,1,1,1,0,0,0)
13	7489	(2,2,3,2,1,1,1,1,0,0,2,0,1,1,1,1,1,1,0,0,0)
14	8353	(4,3,3,3,1,2,1,1,0,0,2,0,1,1,1,1,1,1,0,0,0)
15	9043	(2,2,3,2,1,2,1,1,0,1,2,0,1,1,0,1,1,1,1,0,0)

Table 6: Splitting factors of BCa(30) and corresponding additional parameters

p_i	2	3	5	7	11	13	17	19	31	37	43	61	67	73	79	97	109	139	157
α_i	9	9	9	7	3	6	3	3	1	4	1	3	3	1	3	3	3	3	1
β_i	2	2	3	0	1	1	1	0	0	0	0	0	0	0	0	0	0	0	0
	4	3	5	1	3	2	3	1	1	1	1	1	1	1	1	1	1	1	1
	6	5	9	2		4				2					3	3			
	8	7		3															
				5															

Table 7: Possible β_i for parameter r of BCa(30)

parameter R_j , then a set of 43 parameters of $k_j^3 \cdot \text{BCa}(42) = Q^3 \cdot k_j^3 \cdot \text{BCa}(30)$ is given below:

$k_j \cdot r_i, i = 1, \dots, 42$, because of $k_j^3 \cdot \text{BCa}(42)$, and

$Q \cdot R_j$, because of $Q^3 \cdot (k_j^3 \cdot \text{BCa}(30))$.

Hence, the set of 43 parameters of $k_j^3 \cdot \text{BCa}(42)$ and an upper bound of Ca(43) are obtained.

Example 10. For $k_1 = 487$, all parameters r_i with $i = 1, \dots, 42$ of BCa(42) are relative prime to 487. The magnification $\text{BCa}(42) = Q^3 \cdot \text{BCa}(30)$ holds. Further let

$S = 487^3 \cdot \text{BCa}(42)$, and

$R = 2^4 \cdot 3^5 \cdot 5^3 \cdot 7^2 \cdot 11 \cdot 13^2 \cdot 17 \cdot 31 \cdot 37 \cdot 61 \cdot 67 \cdot 79 \cdot 97 \cdot 109 \cdot 139 \cdot 487^0$,

then R is an additional parameter of $487^3 \cdot \text{BCa}(30)$. Clearly, the 42 parameters of S are $487 \cdot r_i, i = 1, \dots, 42$, because $S = 487^3 \cdot \text{BCa}(42)$, and an additional parameter $r_{43} = Q \cdot R$, because $S = Q^3 \cdot (487^3 \cdot \text{BCa}(30))$. Notice that r_{43} differs from each of $487 \cdot r_i, i = 1, \dots, 42$. Therefore, $487^3 \cdot \text{BCa}(42)$ has 43 parameters, so $487^3 \cdot \text{BCa}(42)$ is an upper bound on $\text{Ca}(43)$, denoted by $\text{SCa}(43)$.

Upper bounds on $\text{Ca}(n)$ with $44 \leq n \leq 57$ can be similarly derived, and are denoted by $\text{SCa}(n)$ with $44 \leq n \leq 57$, respectively.

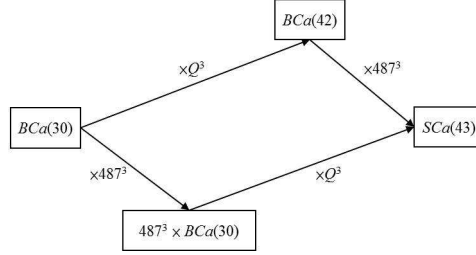

Figure 10: Magnifications among $\text{BCa}(30)$, $487^3 \times \text{BCa}(30)$, $\text{BCa}(42)$, $\text{SCa}(43)$

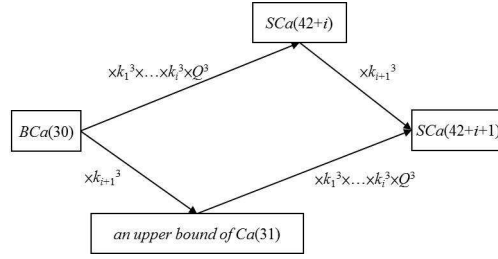

Figure 11: $\text{SCa}(n)$ with $43 \leq n \leq 57$ derived from $\text{BCa}(30)$ by magnifications

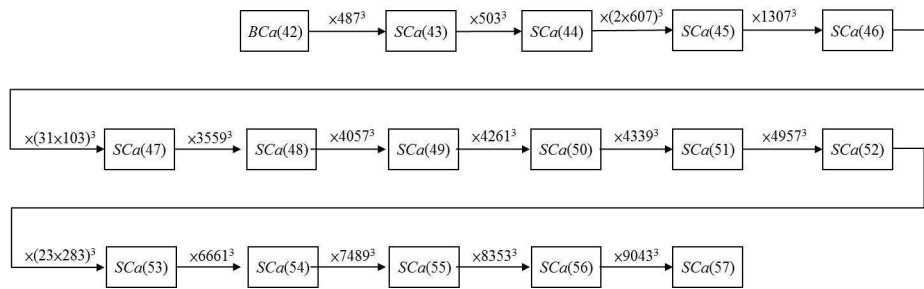

Figure 12: Magnifications among $\text{BCa}(42)$, $\text{SCa}(43)$, \dots , $\text{SCa}(57)$

The above mentioned upper bounds are summarized in Theorem 11. Among them, $\text{SCa}(43)$ and $\text{SCa}(44)$ were included in *OEIS*, August 2014.

Theorem 11.

$$\begin{aligned}
\text{Ca}(43) &\leq \text{SCa}(43) = 487^3 \cdot \text{BCa}(42) \\
\text{Ca}(44) &\leq \text{SCa}(44) = 503^3 \cdot \text{SCa}(43) \\
\text{Ca}(45) &\leq \text{SCa}(45) = (2 \cdot 607)^3 \cdot \text{SCa}(44) \\
\text{Ca}(46) &\leq \text{SCa}(46) = 1307^3 \cdot \text{SCa}(45) \\
\text{Ca}(47) &\leq \text{SCa}(47) = (31 \cdot 103)^3 \cdot \text{SCa}(46) \\
\text{Ca}(48) &\leq \text{SCa}(48) = 3559^3 \cdot \text{SCa}(47) \\
\text{Ca}(49) &\leq \text{SCa}(49) = 4057^3 \cdot \text{SCa}(48) \\
\text{Ca}(50) &\leq \text{SCa}(50) = 4261^3 \cdot \text{SCa}(49) \\
\text{Ca}(51) &\leq \text{SCa}(51) = 4339^3 \cdot \text{SCa}(50) \\
\text{Ca}(52) &\leq \text{SCa}(52) = 4957^3 \cdot \text{SCa}(51) \\
\text{Ca}(53) &\leq \text{SCa}(53) = (23 \cdot 283)^3 \cdot \text{SCa}(52) \\
\text{Ca}(54) &\leq \text{SCa}(54) = 6661^3 \cdot \text{SCa}(53) \\
\text{Ca}(55) &\leq \text{SCa}(55) = 7489^3 \cdot \text{SCa}(54) \\
\text{Ca}(56) &\leq \text{SCa}(56) = 8353^3 \cdot \text{SCa}(55) \\
\text{Ca}(57) &\leq \text{SCa}(57) = 9043^3 \cdot \text{SCa}(56)
\end{aligned}$$

Remark: As pointed by Boyer that 673 is a splitting factor for $\text{BCa}(30)$ which is missing in Table 6, we confirm that

$$r = 2^2 \cdot 3^2 \cdot 5^3 \cdot 7^3 \cdot 11 \cdot 13^2 \cdot 17 \cdot 19 \cdot 37 \cdot 61 \cdot 67^3 \cdot 79 \cdot 97 \cdot 109 \cdot 139 \cdot 673^0$$

is its additional parameter. As a consequence, $\text{SCa}(45), \dots, \text{SCa}(57)$ in Theorem 11 can be improved easily by shifting the splitting factors properly.

5.3 Upper bounds on $\text{Ta}(23)$ and $\text{Ta}(24)$

The strategy that was used in Section 5.2 can be applied to search for upper bounds on $\text{Ta}(23)$ and $\text{Ta}(24)$ in terms of two splitting factors of $\text{BTa}(12)$ and a sequence of magnifications $\text{BTa}(12), \dots, \text{BTa}(16), \text{BTa}(19), \text{BTa}(21)$ and $\text{BTa}(22)$ in the order.

By floating sieving, 47, 627(= 97 × 491) and 91, 037(= 59 × 1543) are two splitting factors of $\text{BTa}(12)$ with additional parameters

$$\begin{aligned}
R_1 &= 2^2 \cdot 3 \cdot 5 \cdot 7 \cdot 13^2 \cdot 17 \cdot 19 \cdot 73 \cdot 79 \cdot 97^0 \cdot 109 \cdot 139 \cdot 491^3, \\
R_2 &= 2^2 \cdot 3 \cdot 5 \cdot 7^2 \cdot 13^2 \cdot 17 \cdot 19 \cdot 59^3 \cdot 79 \cdot 97 \cdot 109 \cdot 139 \cdot 157 \cdot 1543^0
\end{aligned}$$

respectively. Let

$$\begin{aligned}
Q' &= (3 \cdot 61) \cdot 397 \cdot 503 \cdot (2 \cdot 607) \cdot (5^2 \cdot 37 \cdot 181 \cdot 457 \cdot 521) \cdot 4261 \cdot (127 \cdot 197) \cdot (11 \cdot 31 \cdot 103) \\
&= 2 \cdot 3 \cdot 5^2 \cdot 11 \cdot 31 \cdot 37 \cdot 61 \cdot 103 \cdot 127 \cdot 181 \cdot 197 \cdot 397 \cdot 457 \cdot 503 \cdot 521 \cdot 607 \cdot 4261.
\end{aligned}$$

The magnification $\text{BTa}(22) = Q'^3 \cdot \text{BTa}(12)$ holds. Then

$$(97 \cdot 491)^3 \cdot \text{BTa}(22) = (97 \cdot 491)^3 \cdot Q'^3 \cdot \text{BTa}(12)$$

has 22 parameters, which are $97 \cdot 491 \cdot r_i, i = 1, \dots, 22$, where r_1, \dots, r_{22} are the parameters of BTa(22) as shown in Table 12, together with an additional parameter

$$Q' \cdot R_1 = 2^3 \cdot 3^2 \cdot 5^3 \cdot 7 \cdot 11 \cdot 13^2 \cdot 17^1 \cdot 19^1 \cdot 31 \cdot 37 \cdot 61 \cdot 73 \cdot 79 \cdot 103 \cdot 109 \cdot 127 \cdot 139 \cdot 181 \cdot 197 \\ \cdot 397 \cdot 457 \cdot 491^3 \cdot 503 \cdot 521 \cdot 607 \cdot 4261,$$

which differs from the previous 22 parameters, so $(97 \cdot 491)^3 \cdot \text{BTa}(22)$ has 23 parameters, and $(97 \cdot 491)^3 \cdot \text{BTa}(22)$ gives an upper bound on Ta(23), denoted by STa(23),

$$\text{STa}(23) = (97 \cdot 491)^3 \cdot \text{BTa}(22).$$

Similarly,

$$\text{STa}(24) = (59 \cdot 1543)^3 \cdot \text{STa}(23)$$

is an upper bound on Ta(24). Theorem 12 summarizes the above results. Both upper bounds STa(23) and STa(24) were included in *OEIS*, October 2014.

Theorem 12.

$$\text{Ta}(23) \leq \text{STa}(23) = 97^3 \cdot 491^3 \cdot \text{BTa}(22), \\ \text{Ta}(24) \leq \text{STa}(24) = 59^3 \cdot 1543^3 \cdot \text{STa}(23).$$

6 Acknowledgement

The author would like to thank Prof. C. Boyer for suggestive comments on the original version of this paper; in particular, for pointing out additional splitting factors for BCa(30).

7 Appendix

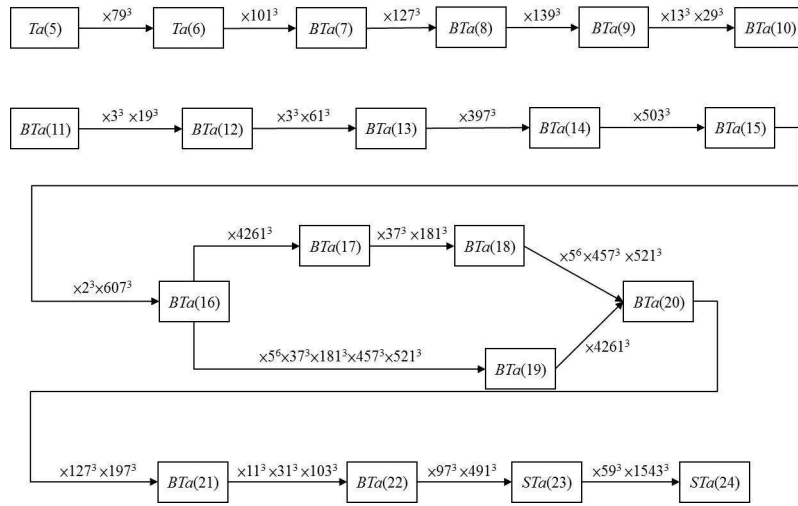

Figure 13: Magnifications among $Ta(5)$, $Ta(6)$, $BTa(7)$, \dots , $BTa(22)$, $STa(23)$, $STa(24)$

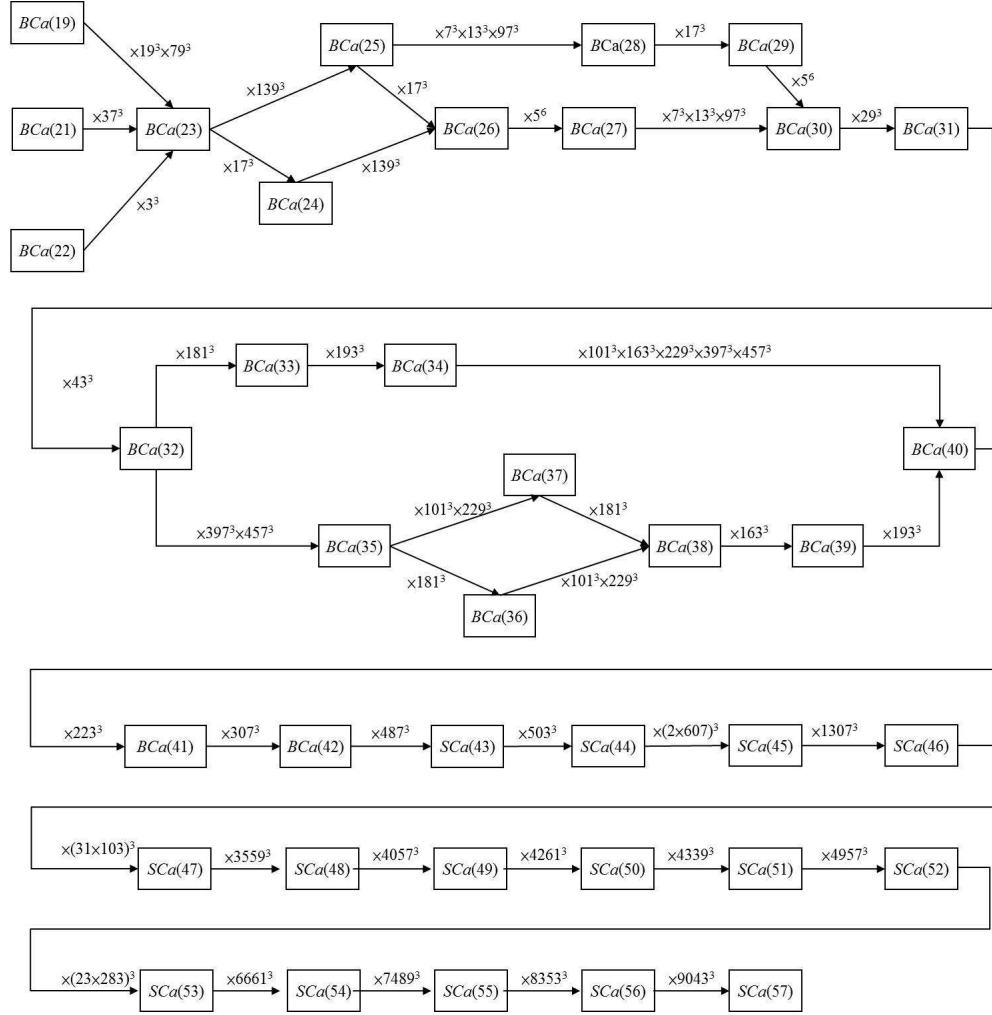

Figure 14: Magnifications among $BCa(19), BCa(21) \dots, BCa(42), SCa(43), \dots, SCa(57)$

	2	3	5	7	11	13	19	31	37	43	61	67	73	79	109	157	a_i
r_1	2	1	1	0	3	1	1	1	1	0	1	1	0	1	1	0	15
r_2	2	1	1	1	1	1	1	0	2	0	1	0	1	1	1	0	14
r_3	2	1	1	1	1	1	1	1	2	0	1	1	0	0	1	1	15
r_4	2	1	1	1	1	1	3	0	1	0	1	1	1	0	1	0	15
r_5	2	1	1	1	1	3	1	0	2	1	1	1	0	1	0	0	16
r_6	2	1	1	2	1	1	1	0	0	0	1	1	0	1	1	0	13
r_7	2	1	1	2	1	1	1	0	1	1	1	1	0	1	1	0	15
r_8	2	1	1	2	1	1	1	1	1	0	1	0	0	1	1	1	15
r_9	2	1	1	4	1	3	1	0	0	0	1	1	0	1	1	0	17
r_{10}	2	1	3	1	1	1	1	0	1	1	1	1	0	1	0	1	16
r_{11}	2	2	1	0	1	1	1	0	2	0	1	1	0	1	1	1	15
r_{12}	2	2	1	2	1	1	1	0	1	1	1	1	1	1	0	0	16
r_{13}	2	4	1	1	1	1	0	1	2	0	1	1	0	1	1	0	17
r_{14}	4	1	1	1	3	1	1	0	1	0	0	1	0	1	1	1	17
r_{15}	4	1	1	2	1	0	1	1	2	0	1	1	0	1	1	0	17
r_{16}	4	2	1	1	1	0	1	0	1	1	1	1	0	3	0	0	17
r_{17}	4	2	1	1	1	1	1	0	1	1	1	1	0	1	1	0	17
r_{18}	4	2	1	2	1	0	1	0	2	0	0	1	1	1	1	0	17
r_{19}	6	1	1	1	1	1	1	0	1	0	1	1	1	1	1	0	18
r_{20}	6	1	1	1	1	1	1	1	1	1	0	1	0	1	1	0	18
r_{21}	8	1	1	2	1	1	1	0	2	0	1	0	0	1	1	0	20
r_{22}	8	1	3	1	1	1	1	0	1	0	1	1	0	1	1	0	21

Table 8: 22 parameters for BCa(22)

	2	3	5	7	11	13	17	19	31	37	43	61	67	73	79	97	109	139	157
r_1	2	2	3	1	3	2	1	1	1	1	0	1	1	0	1	1	1	1	0
r_2	2	2	3	2	1	2	1	1	0	2	0	1	0	1	1	1	1	1	0
r_3	2	2	3	2	1	2	1	1	1	2	0	1	1	0	0	1	1	1	1
r_4	2	2	3	2	1	2	1	3	0	1	0	1	1	1	0	1	1	1	0
r_5	2	2	3	2	1	4	1	1	0	2	1	1	1	0	1	1	0	1	0
r_6	2	2	3	3	1	2	1	1	0	0	0	1	1	0	1	1	1	1	0
r_7	2	2	3	3	1	2	1	1	0	1	1	1	1	0	1	1	1	1	0
r_8	2	2	3	3	1	2	1	1	1	1	0	1	0	0	1	1	1	1	1
r_9	2	2	3	3	1	2	3	1	0	1	0	1	1	0	1	1	1	1	0
r_{10}	2	2	3	5	1	4	1	1	0	0	0	1	1	0	1	1	1	1	0
r_{11}	2	2	5	2	1	2	1	1	0	1	1	1	1	0	1	1	0	1	1
r_{12}	2	2	5	3	1	2	1	1	1	1	1	1	1	0	1	1	1	0	0
r_{13}	2	3	3	1	1	2	1	1	0	2	0	1	1	0	1	1	1	1	1
r_{14}	2	3	3	3	1	2	1	1	0	1	0	1	1	1	1	0	1	1	1
r_{15}	2	3	3	3	1	2	1	1	0	1	1	1	1	1	1	1	0	1	0
r_{16}	2	3	9	1	1	1	1	1	0	2	1	1	0	0	1	1	1	0	0
r_{17}	2	5	3	2	1	2	1	0	1	2	0	1	1	0	1	1	1	1	0
r_{18}	2	2	3	2	1	0	1	1	0	2	0	1	1	0	1	3	1	1	0
r_{19}	4	2	3	2	3	2	1	1	0	1	0	0	1	0	1	1	1	1	1
r_{20}	4	2	3	3	1	1	1	1	1	2	0	1	1	0	1	1	1	1	0
r_{21}	4	2	5	2	1	2	1	1	0	1	1	1	1	1	1	1	1	0	0
r_{22}	4	3	3	2	1	1	1	1	0	1	1	1	1	0	3	1	0	1	0
r_{23}	4	3	3	2	1	2	1	1	0	1	1	1	1	0	1	1	1	1	0
r_{24}	4	3	3	3	1	1	1	1	0	2	0	0	1	1	1	1	1	1	0
r_{25}	6	2	3	2	1	2	1	1	0	1	0	1	1	1	1	1	1	1	0
r_{26}	6	2	3	2	1	2	1	1	1	1	1	0	1	0	1	1	1	1	0
r_{27}	6	7	3	2	1	2	1	1	1	1	0	0	1	0	1	1	1	1	0
r_{28}	8	2	3	0	1	4	1	1	0	1	0	1	1	1	1	0	1	1	0
r_{29}	8	2	3	3	1	2	1	1	0	2	0	1	0	0	1	1	1	1	0
r_{30}	8	2	5	2	1	2	1	1	0	1	0	1	1	0	1	1	1	1	0

Table 9: 30 parameters for BCa(30)

	2	3	5	7	11	13	17	19	29	31	37	43	61	67	73	79	97	101	109	139	157	163	181	193	223	229	307	397	457
r_1	2	2	3	1	3	2	1	1	1	1	1	1	1	1	0	1	1	1	1	1	0	1	1	1	1	1	1	1	1
r_2	2	2	3	2	1	2	1	1	1	0	2	1	1	0	1	1	1	1	1	1	0	1	1	1	1	1	1	1	1
r_3	2	2	3	2	1	2	1	1	1	1	2	1	1	1	0	0	1	1	1	1	1	1	1	1	1	1	1	1	1
r_4	2	2	3	2	1	2	1	3	1	0	1	1	1	1	1	0	1	1	1	1	0	1	1	1	1	1	1	1	1
r_5	2	2	3	2	1	4	1	1	1	0	2	2	1	1	0	1	1	1	0	1	0	1	1	1	1	1	1	1	1
r_6	2	2	3	3	1	2	1	1	1	0	0	1	1	1	0	1	1	1	1	1	0	1	1	1	1	1	1	1	1
r_7	2	2	3	3	1	2	1	1	1	0	1	2	1	1	0	1	1	1	1	1	0	1	1	1	1	1	1	1	1
r_8	2	2	3	3	1	2	1	1	1	1	1	1	1	0	0	1	1	1	1	1	1	1	1	1	1	1	1	1	1
r_9	2	2	3	3	1	2	3	1	1	0	1	1	1	1	0	1	1	1	1	1	0	1	1	1	1	1	1	1	1
r_{10}	2	2	3	5	1	4	1	1	1	0	0	1	1	1	0	1	1	1	1	1	0	1	1	1	1	1	1	1	1
r_{11}	2	2	5	2	1	2	1	1	1	0	1	2	1	1	0	1	1	1	0	1	1	1	1	1	1	1	1	1	1
r_{12}	2	2	5	3	1	2	1	1	1	1	1	2	1	1	0	1	1	1	1	0	0	1	1	1	1	1	1	1	1
r_{13}	2	3	3	1	1	2	1	1	1	0	2	1	1	1	0	1	1	1	1	1	1	1	1	1	1	1	1	1	1
r_{14}	2	3	3	3	1	2	1	1	1	0	1	1	1	1	1	0	1	1	1	1	1	1	1	1	1	1	1	1	1
r_{15}	2	3	3	3	1	2	1	1	1	0	1	2	1	1	1	1	1	1	0	1	0	1	1	1	1	1	1	1	1
r_{16}	2	3	9	1	1	1	1	1	1	0	2	2	1	0	0	1	1	1	1	0	0	1	1	1	1	1	1	1	1
r_{17}	2	5	3	2	1	2	1	0	1	1	2	1	1	1	0	1	1	1	1	1	0	1	1	1	1	1	1	1	1
r_{18}	4	2	3	2	3	2	1	1	1	0	1	1	0	1	0	1	1	1	1	1	1	1	1	1	1	1	1	1	1
r_{19}	4	2	3	3	1	1	1	1	1	1	2	1	1	1	0	1	1	1	1	1	0	1	1	1	1	1	1	1	1
r_{20}	4	2	5	2	1	2	1	1	1	0	1	2	1	1	1	1	1	1	1	0	0	1	1	1	1	1	1	1	1
r_{21}	4	3	3	2	1	1	1	1	1	0	1	2	1	1	0	3	1	1	0	1	0	1	1	1	1	1	1	1	1
r_{22}	4	3	3	2	1	2	1	1	1	0	1	2	1	1	0	1	1	1	1	1	0	1	1	1	1	1	1	1	1

Table 10: 42 parameters for BCa(42) (part a)

	2	3	5	7	11	13	17	19	29	31	37	43	61	67	73	79	97	101	109	139	157	163	181	193	223	229	307	397	457
r_{23}	4	3	3	3	1	1	1	1	1	0	2	1	0	1	1	1	1	1	1	1	0	1	1	1	1	1	1	1	1
r_{24}	6	2	3	2	1	2	1	1	1	0	1	1	1	1	1	1	1	1	1	1	0	1	1	1	1	1	1	1	1
r_{25}	6	2	3	2	1	2	1	1	1	1	1	2	0	1	0	1	1	1	1	1	0	1	1	1	1	1	1	1	1
r_{26}	6	7	3	2	1	2	1	1	1	1	1	1	0	1	0	1	1	1	1	1	0	1	1	1	1	1	1	1	1
r_{27}	8	2	3	0	1	4	1	1	1	0	1	1	1	1	1	0	1	1	1	1	0	1	1	1	1	1	1	1	1
r_{28}	8	2	3	3	1	2	1	1	1	0	2	1	1	0	0	1	1	1	1	1	0	1	1	1	1	1	1	1	1
r_{29}	8	2	5	2	1	2	1	1	1	0	1	1	1	1	0	1	1	1	1	1	0	1	1	1	1	1	1	1	1
r_{30}	2	2	3	2	1	0	1	1	1	0	2	1	1	1	0	1	3	1	1	1	0	1	1	1	1	1	1	1	1
r_{31}	2	2	3	2	1	2	1	1	3	0	1	1	1	1	0	1	1	1	1	1	0	1	1	1	1	1	1	1	1
r_{32}	2	3	5	2	1	2	1	1	3	0	1	0	1	1	0	1	1	1	1	1	0	1	1	1	1	1	1	1	1
r_{33}	2	2	9	2	1	2	1	1	1	0	1	1	1	1	1	1	1	1	1	1	0	1	1	1	1	1	1	1	0
r_{34}	2	5	3	1	1	2	1	1	1	1	1	2	1	1	0	1	1	1	1	1	1	1	1	1	1	1	1	1	0
r_{35}	4	2	7	3	1	2	1	1	1	1	2	1	1	1	0	1	1	1	1	1	0	1	1	1	1	1	1	1	0
r_{36}	4	2	3	0	1	2	1	1	1	0	1	1	1	1	0	1	1	3	1	1	1	1	1	1	1	0	1	1	1
r_{37}	6	3	3	5	1	2	1	1	1	0	2	1	1	1	1	1	1	1	1	1	0	1	1	1	1	0	1	0	1
r_{38}	2	5	5	3	1	2	1	1	1	1	0	1	1	1	1	1	1	1	1	1	0	1	0	1	1	1	1	1	1
r_{39}	2	2	3	5	1	2	1	0	1	0	1	1	1	1	0	1	1	1	1	1	1	3	0	1	1	1	1	0	1
r_{40}	2	2	3	2	1	2	1	1	1	0	1	2	1	1	0	1	1	1	1	1	1	1	1	0	1	1	1	1	1
r_{41}	6	3	3	2	1	2	1	1	1	0	1	1	1	1	0	1	1	1	1	1	1	1	1	1	0	1	1	1	1
r_{42}	2	3	3	2	1	2	1	1	1	0	1	1	1	1	0	1	1	1	1	1	0	1	1	1	1	0	3	1	1

Table 11: 42 parameters for BCa(42) (part b)

	2	3	5	7	11	13	17	19	31	37	43	61	73	79	97	103	109	127	139	157	181	197	397	457	503	521	607
r_1	3	2	9	1	1	2	1	1	1	1	0	1	1	1	1	1	1	1	1	0	1	1	1	0	1	1	1
r_2	3	2	3	1	1	4	1	1	1	2	1	1	0	1	1	1	0	1	1	0	1	1	1	1	1	1	1
r_3	3	3	7	1	1	1	1	1	1	0	0	1	0	1	1	1	1	1	1	0	1	1	1	0	1	3	1
r_4	3	3	3	0	1	2	1	1	1	2	1	1	0	1	1	1	0	0	1	0	1	3	1	1	1	1	1
r_5	3	3	3	2	3	2	1	1	0	1	1	1	1	1	1	0	1	1	1	0	1	1	1	1	1	1	1
r_6	3	2	3	1	1	0	1	1	1	2	0	1	0	1	3	1	1	1	1	0	1	1	1	1	1	1	1
r_7	3	2	3	0	1	2	1	0	1	1	0	1	0	1	1	1	1	1	1	0	1	1	1	1	1	3	1
r_8	3	2	3	1	1	2	1	1	2	2	0	1	0	0	1	1	1	1	1	1	1	1	1	1	1	1	1
r_9	3	2	5	2	1	2	1	1	2	1	1	1	0	1	1	1	1	1	0	0	1	1	1	1	1	1	1
r_{10}	3	3	3	0	1	2	1	1	1	2	0	1	0	1	1	1	1	1	1	1	1	1	1	1	1	1	1
r_{11}	3	2	3	2	1	2	3	1	1	1	0	1	0	1	1	1	1	1	1	0	1	1	1	1	1	1	1
r_{12}	3	3	3	2	1	2	1	1	1	1	0	1	1	1	0	1	1	1	1	1	1	1	1	1	1	1	1
r_{13}	3	5	3	0	1	2	1	1	2	1	1	1	0	1	1	1	1	1	1	1	1	1	0	1	1	1	1
r_{14}	3	5	3	1	1	2	1	0	2	2	0	1	0	1	1	1	1	1	1	0	1	1	1	1	1	1	1
r_{15}	3	5	5	2	1	2	1	1	2	0	0	1	1	1	1	1	1	1	1	0	0	1	1	1	1	1	1
r_{16}	5	3	3	1	1	1	1	1	1	1	1	1	0	3	1	1	0	1	1	0	1	1	1	1	1	1	1
r_{17}	5	2	5	1	1	2	1	1	1	1	1	1	1	1	1	1	1	1	0	0	1	1	1	1	1	1	1
r_{18}	5	2	3	2	1	1	1	1	2	2	0	1	0	1	1	1	1	1	1	0	1	1	1	1	1	1	1
r_{19}	5	2	3	2	1	2	1	1	1	2	1	1	0	1	1	1	1	1	1	1	1	1	1	1	1	1	1
r_{20}	7	7	3	1	1	2	1	1	2	1	0	0	0	1	1	1	1	1	1	0	1	1	1	1	1	1	1
r_{21}	9	2	5	1	1	2	1	1	1	1	0	1	0	1	1	1	1	1	1	0	1	1	1	1	1	1	1
r_{22}	11	2	3	1	1	2	1	1	2	1	0	0	1	1	1	1	1	1	1	1	1	1	1	1	1	1	0

Table 12: 22 parameters for BTa(22)

References

- [1] C. Boyer, New upper bounds for Taxicab and Cabtaxi numbers. *J. Integer Sequences*, **11** (2008), [Article 08.1.6](#).
- [2] C. Boyer, New upper bounds for Taxicab and Cabtaxi numbers. Available at <http://www.christianboyer.com/taxicab/>.
- [3] C. S. Calude, E. Calude and M. J. Dinneen, What is the value of Taxicab(6)?, *J. Univ. Comput. Sci.* **9** (2003), 1196–1203.
- [4] G. H. Hardy and E. M. Wright, *An Introduction to the Theory of Numbers*, Fifth edition, Oxford University Press, 1980.
- [5] D. W. Wilson, The fifth Taxicab number is 48988659276962496, *J. Integer Sequences*, **2** (1999), [Article 99.1.9](#).
- [6] N. J. A. Sloane, *On-Line Encyclopedia of Integer Sequences*, <http://oeis.org>.

2010 *Mathematics Subject Classification*: Primary 11D25.

Keywords: Taxicab number, Cabtaxi number, magnification, splitting factor, sieving, floating sieving.

(Concerned with sequences [A011541](#) and [A047696](#).)

Received April 29 2015; revised versions received November 17 2015; January 20 2016; March 28 2016. Published in *Journal of Integer Sequences*, April 21 2016.

Return to [Journal of Integer Sequences home page](#).